



HEAT PUMP

for swimming pool water
heating & cooling

Installation and user manual



HP 1100 GREEN INVERTER PRO

&

**HP 1500 GREEN INVERTER PRO
COMPACT & SPLIT**

Version: 01/2021

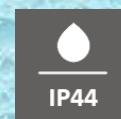



Thank you for purchasing Microwell swimming pool heat pump. Before you use this device, it is necessary to carefully read the entire Installation and user manual. It is not allowed to commence the heat pump installation or operation unless full content of this Installation and user manual is understood and acknowledged. Please keep the Installation and user manual available in the case of any future reference is required. Please provide this information also to each user of the device. Please mind local regulations in your country regarding installation and usage of this heat pump which are valid in addition to this User manual.

Contents

1. INTRODUCTION	4
1.1 Product description	4
1.2 Package checking.....	5
1.3 Waste disposal information	5
2. SAFETY MEASURES	6
2.1 Electrical safety.....	6
2.2 Usage precautions	6
2.3 Handling precautions	9
3. TECHNICAL SPECIFICATION	10
3.1 Technical data.....	10
3.2 Swimming pool water parameters	11
3.3 Heat pump dimensions	12
3.4 Description of the basic parts.....	12
3.5 Installation reminder	13
3.6 Accessories	14
3.7 Electric wiring Diagram.....	14
4. REGULATION.....	20
4.1 Description of the LCD panel.....	20
4.2 Operation Instruction.....	21
4.3 Testing	24
5. WIFI OPERATION	26
6. TROUBLE SHOOTING FOR COMMON FAULTS	30
6.1 Repairing Guidance	30
6.2 Failure solution and code	30
7. MAINTANANCE.....	32

- 8. SPLIT – CONNECTION AND INSTALLATION 33
 - Refrigerant circuit connection..... 34
 - Flaring work..... 35
 - Water unit dimensions..... 38
- 9. Warranty 39



1. INTRODUCTION

In your hands you hold probably the most advanced and the most efficient heat pump currently available on the market. This heat pump provides warm water in your pool at lowest possible cost. The heat pump is manufactured in tightest accordance with related strict standards and norms, in order to provide high quality operation and long-term reliability.

This Installation and user manual contains all the necessary information about the installation, operation and maintenance of the heat pump. Please read this Installation and user manual carefully before you start to use this product. The manufacturer is not responsible for any personal or property damage due to the improper installation, use or maintenance that is not in accordance with this User Manual.

This Installation and user manual is an inseparable part of this product; therefore it must be kept in good condition and must accompany the heat pump.

1.1 Product description

The heat pump is designed exclusively for swimming pool water heating or cooling and maintaining its temperature on the requested level. Other appropriate application is water temperature conditioning for fish tanks, wine ciders or horse cooling facilities. These applications should be discussed with local installer or distributor. Any other form of application is considered inappropriate.

The heat pump achieves the highest efficiency at 15÷35°C air temperature. At ambient air temperatures lower than -15°C the efficiency of the device decreases and at the temperatures higher than +40°C the heat pump can get overheated which may result in its malfunction, damage or failure. Do not use the product out of the designated operational air temperature range which is stated in section 3.1 *Technical data*.

This heat pump is designed for swimming pools with up to 40 m³ - HP 1000 and up to 60 m³ - HP 1400 of pool water volume. For proper operations there must be water flow through the exchanger of the heat pump (within water filtration circuit) in the range of 4-6 m³/h.

The heat pump enables heat gain from the external air surrounding the swimming pool through the compression – expansion cycles of the heat-carrying liquid. The air is driven by a fan through the evaporator where it will deliver its heat to the heat-carrying liquid (the air is being cooled at the same time). The heat-carrying liquid is then delivered to the spirals of the exchanger by the compressor which pressurises it and thus heats it up. In these spirals, the heat-carrying liquid delivers its heat to the swimming pool water. From the exchanger there is a cooled liquid flowing to the expansion valve or capillary where its pressure decreases and it gets cooled down rapidly at the same time. This cooled liquid flows to the evaporator again where it gets heated by the flowing air. The whole process runs fully automatically and is monitored by the pressure and temperature sensors. The same principle is applied when heat pump operates in cooling mode.

Using simple language, a heat pump is able to extract the heat/cold that is present in ambient environment and leveraged pass it into the pool water. When heating, higher the ambient air temperature is, more free energy can the heat pump extract and thus reach higher efficiency. At favourable conditions you pay around 15% of heat, i.e. 85% of heat is free. Please review below drawing of different ambient air conditions with subsequent efficiencies.

The heat pump efficiency grows by the increasing surrounding air temperature.

It takes some days to achieve the requested swimming pool water temperature. This time period depends on heat loss and heat gain balance of your pool.

Example factors of heat losses: poor pool construction, used materials, usage of cover, air – water temperature relationship, fresh water refilling, filtration, etc.

Example factors of heat gains: intensity of sun, winds, orientation of pool, air – water temperature relationship, etc.

In order to avoid heat loss when the swimming pool is not being used, it is highly advised to use pool's cover.

Ideal water temperature for external pools is considered at levels from 27° to 32°C. This may change based on particular demands of the user. When setting the desired air temperature higher than 32°C please review the material characteristics of your pool parts. High water temperature can damage these materials and contribute

to creation of algae. Manufacturer, distributor and reseller do not bear responsibility resulting from inappropriate heat pump usage.

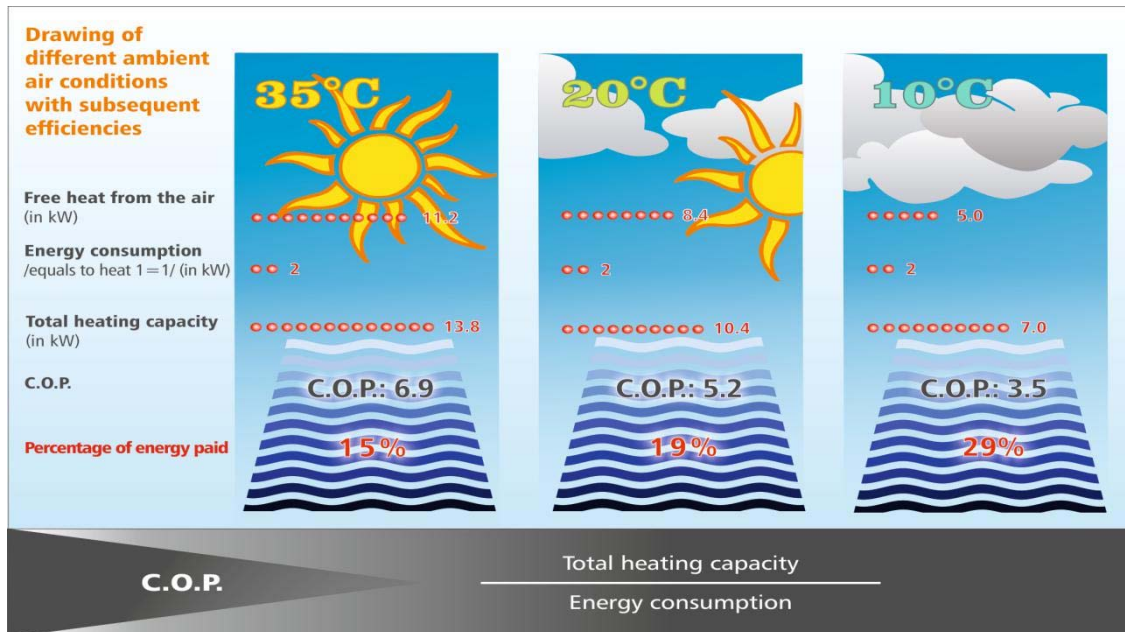

1.2 Package checking

The unit was delivered in carton box on a wooden palette. Do not accept the package if it shows signs of damage. If the package appears intact, please unpack the unit and check the content. It should include the following:

1. The heat pump – condensing unit, the heat exchanger – indoor unit. Please see section 3.4 Description of the basic parts to see how the heat pump looks like
2. This Installation and user manual
3. Four rubber silent blocks

1.3 Waste disposal information

When using this heat pump in the European countries, the following information must be followed:

DISPOSAL: Do not dispose this product as unsorted municipal waste. It is prohibited to dispose this heat pump in domestic / household waste. It is prohibited to dispose this appliance into forests or natural landscape. This could lead into local soil pollution. Collection of such waste must be treated individually.



DISPOSAL POSSIBILITIES:

1. The municipality has established a collection system where electronic waste can be disposed.
2. When buying a new product, the retailer or the manufacturer may take back the old appliance free of charge.
3. Old appliance may contain valuable resources which could be sold to scrap material dealers.
4. Disposal of packaging materials such as carton box or plastic / bubble foil can be recycled.



2. SAFETY MEASURES

It is necessary to follow instructions in this Installation and user manual and local regulations in your country that regulate the installation and usage of this device. Incorrect, improper or operations contradictory to this Installation and user manual may lead to an injury or property damage and will lead to loss of warranty. To prevent injury or property damage the following instructions must be followed:

2.1 Electrical safety



- *The device operates at dangerous electrical current.*
- *Only authorized person with particular electro-technical qualification can manipulate with unit.*
- *Danger of electrical shock.*
- *Do not exceed the required power supply.*
- *Do not turn the device on that shows signs of possible damage such as broken packaging, broken or otherwise damaged unit's chassis or cover, smoke, smell, etc.*
- *It is necessary to use appropriate Residual current circuit breaker (RCD) for connection of the heat pump to main power supply.*
- *Do not manipulate with the device with wet hands.*
- *Do not clean the device with water.*
- *Before cleaning the device, switch off the circuit breaker of the unit's power supply.*
- *Installation, service or repair must be performed by qualified technician.*
- *When the device is not intended to be used for a longer time, we recommend switching the circuit breaker of the unit's power supply off.*
- *Unit must be installed in vertical position to avoid condensate water to enter electrical part of the unit.*
- *It is forbidden to install the unit close to devices that may cause electrical or frequency disturbance such as welding machines, motors or rotors, WIFI/WLAN routers or repeaters.*
- *It is forbidden to alter electrical installation of the device. It is also forbidden to alter any other part or functionality of the device.*

2.2 Usage precautions

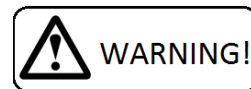

Do not cover or block the intake or exhaust opening / ventilator and evaporator covers. It is forbidden to block or cover the intake or exhaust openings with clothes, towels, buckets, canoes, trees, etc. Such action would lead to a decrease of needed airflow. That would result in heat pump inefficiency and underperformance, eventually to heat pump overeat with subsequent security turning off, malfunction, failure or damage. Especially during bloom months it is highly advised to keep the evaporator fins clean.

- *Do not climb up on or sit on the unit.*
- *Do not place any objects on the top of the unit (e.g. boxes, flower vases, etc.).*
- *Do not spray any flammable substances into the equipment; this might lead to fire.*
- *Do not clean the equipment with aggressive cleaning agents, this might lead to damage or deformations.*
- *When cleaning plastic parts do not use any cleaning agents unsuitable for plastic (household cleaning agents, solvents, bleaching agents, benzene, diluents, rough cleaning powder, cresol, chemical agents). Instead, sweep the heat pump cover with a soft cloth or a sponge.*
- *Never throw or insert any objects into any hose or opening.*
- *The cover is made of metal. Do not manipulate with lighted cigarette, cigarette ashes, or any other kind of fire in vicinity to this part.*
- *Use this device exclusively for the intended purpose, as described in the attached instruction manual. Do not use parts which are not recommended.*
- *Never block the air opening of the product. Protect the air openings from clogging by particles.*
- *Do not drink or use the condensate water drained from the unit. Do not return the water back to*

the swimming pool. The water may be contaminated with bacteria.



- Children are not allowed to operate, touch or play with the unit.
- **Children are not allowed to manipulate with packaging, plastic / bubble foil. Risk of suffocation!**
- Prevent the children from injury or harm caused by any manipulation with the unit, its parts or its packaging. Small parts like screws may be swallowed and cause harm to health.
- Do not leave the children in the swimming pool / at the swimming pool unattended.
- The positioning of the heat pump must be in accordance with the STN 33 2000-7-702 standard, i.e. it must be placed at least 3,5 m from the swimming pool's external border.
- For heating/cooling the swimming pool by the heat pump, the filtration pump must run and the water must flow through the heat exchanger.
- Never turn on the heat pump if it is without water and if the filtration device is not operating.
- Protect the heat pump from freezing. Eliminate the water from the filtration and from the heat pump's water heat exchanger and prepare the product for the winter time.
- At low surrounding ambient temperature level (below 10°C) and high relative air humidity level (e.g. after rain, during the night, etc.), the evaporator may get iced up. Heat pump will automatically defreeze itself. Its operations or functionality is not harmed but the efficiency decreases.
- Manufacturer does not bear any responsibility concerning damages caused by inappropriate heat pump selection, installation or application.
- Do not pressurize the water heat exchanger higher than 0.25MPa (2.5bar). By pressure of 0.5MPa (5bar) the water heat exchanger gets irreversibly damaged. It is advised to install a security valve with pressure threshold at 0.25MPa (2.5Bar) before the heat exchanger.
- Do not apply or use water of higher temperature than 45°C in water heat exchanger. Water temperature above 60°C irreversibly damages the water heat exchanger.
- Manufacturer does not bear any responsibility concerning damages caused by inappropriate heat pump performance and/or model selection, installation or application. Heat pump is considered undersized in the case it works usually and in long-term more than 18 hours daily. General warranty void applies for damages on the device or other damages if the device works usually in long-term more than 18 hours daily.
- The heat pump must be correctly sized for its application.
- Refrigerant connection between the water and the condensing unit must comply with local refrigerant regulations. Typically, the refrigerant circuit must be sealed. Manufacturer does not bear any responsibility for damages caused by incorrect refrigerant works.

Warning



a. The WARNING sign denotes a hazard. It calls attention to a procedure, practice, or the like, which, if not correctly performed or adhered to, could result in personal injury or injury to a third party. These signs are rare, but are extremely important.

	<p>a. Keep the heat pump away from fire source.</p>
	<p>b. It must be placed in well ventilated area, indoor or closed area is not allowed.</p>

	c. Repair and disposal must be carried out by trained service personnel
	d. Vacuumize completely before welding. Welding can only be carried out by professional personnel in service center.

1) Attention

- a. Please read the following instructions before installation, use and maintenance.
- b. Installation must be done by professional staff only in accordance with this manual.
- c. A leakage test must be performed after installation.
- d. If a repair is required, please contact the nearest after-sales service center. The repair process must be strictly in accordance with manual. All repair practice by non-professional is prohibited.
- e. Set proper temperature in order to get comfortable water temperature to avoid overheating or overcooling.
- f. Please don't stack substances, which will block air flow near inlet or outlet area, otherwise the efficiency of the heater will be reduced or even stopped.
- g. Don't use or stock combustible gas or liquid such as thinners, paint and fuel to avoid fire.
- h. In order to optimize the heating effect, please install heat preservation insulation on pipes between swimming pool and the heater, and please use a recommended cover on the swimming pool.
- i. Connecting pipes of the swimming pool and the heater should be $\leq 10\text{m}$.

2) Safety

- a. Please keep the main power supply switch far away from the children.
- b. When a power cut happens during operating, and later the power is restored, the heater will start up.
- c. Please switch off the main power supply in lightening and storm weather to prevent from machine damage that caused by lightning;
- d. Any repairing should be conducted in the area with good ventilation. The ignition source is prohibited during the inspection.
- e. Safety inspection must be carried before the maintenance or repair for heat pumps with R32 gas in order to minimize the risk.
- f. If R32 gas leaks during the installation process, all operations must be stopped immediately and call the service center.

2.3 Handling precautions



- Leave the condensing unit in vertical upright position for at least 2 hours before the installation.
- Transport in lying position or turning the device over may harm the compressor resulting in unit's malfunction, failure or damage and will lead to loss of warranty.
- The device must be handled with care and special attention avoiding any mechanical damage.
- It is forbidden to apply any improper mechanical force onto the unit. This may cause mechanical damage to the device.
- It is forbidden to let the device fall freely onto the ground or any solid surface resulting in hard impact.
- Please notify your reseller or distributor if you suspect that the unit was delivered damaged. Unit may seem to work well at start but small damage can make the unit go out-of-order in short time. In such case the unit must be inspected and approved for further use by your reseller.
- Please notify your reseller or distributor if directly after installation you suspect that unit is not working in perfect order.
- In the case of device failure resulting from improper handling or mechanical damage (impact, hit, fall, etc.), the manufacturer reserves the right to evaluate the continuity of warranty.

2.4 Transportation

a. Always keep upright

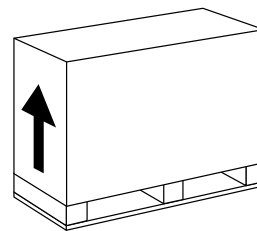

b. Do not lift the water union

(If so, the titanium heat exchanger
inside the heat pump may be damaged)

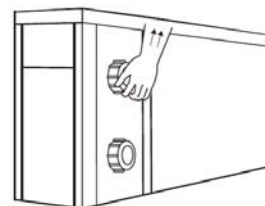

3. TECHNICAL SPECIFICATION

3.1 Technical data

Model	HP1100 GREEN INVERTER PRO	HP1500 GREEN INVERTER PRO
PERFORMANCE CONDITION: Air 27°C/ Water 27°C/ Humid. 80%		
Heating capacity (kW)	10.8	15
COP Range	14~6.4	15~6.6
PERFORMANCE CONDITION: Air 15°C/ Water 26°C/ Humid. 70%		
Heating capacity (kW)	7.7	10.5
COP Range	7.5~4.5	7.7~4.6
PERFORMANCE CONDITION: Air 35°C/ Water 28°C/ Humid. 80%		
Cooling capacity (kW)	4.5	6.7
TECHNICAL SPECIFICATIONS		
Advised pool volume (m ³) *	30~40	40~60
Operating air temperature (°C)	-5°C~43°C	
Rated input power (kW)	0.20~1.71	0.27~2.28
Rated input current (A)	0.87~7.4	1.17~9.91
Maximum input current (A)	10	13.5
Power cord (mm ²)	3X2.5	3X2.5
Sound level at 10m dB(A)	18.1~29.4	20.8~24.5
Advised water flow (m ³ /h)	3~5	5~7
Water connection (mm)	50	
Compressor	Full Stepless DC inverter compressor	
Fan	DC Inverter	
Expansion	EEV	
Casing	ABS UV resistant on a metal chassis	
Heat exchanger	Titanium Grade 1 ASTM B265, twisted tube in plastic body	
Winter accessories	Winter module (compressor heater 30W) and Goldfin condensate heater 45W	
WIFI	Standard worldwide, IEEE802.11 b/g/n; 2,412 - 2,484 GHz	

* The manufacturer reserves the right to change the parameters without notice.

** In the case Winter module, condensate tray antifreeze or heat exchanger frost protection is installed.

The refrigerant circuit is filled with R32.

Refrigerant R32 also called HFC-32 or difluoromethane. R32 is a molecule used as refrigerant that has zero ozone depletion potential (ODP).

R32 with the global warming potential (GWP) index 675 times that of carbon dioxide, based on a 100-year time frame, and it is classified as A2L - slightly flammable by ASHRAE.



Operating condition and range:

- a. Air temperature operating range: $-5^{\circ}\text{C} \sim 43^{\circ}\text{C}$
- b. Heating temperature setting range: $18^{\circ}\text{C} \sim 40^{\circ}\text{C}$
- c. Cooling temperature setting range: $12^{\circ}\text{C} \sim 30^{\circ}\text{C}$

The heat pump will have ideal performance in the operation range Air $15^{\circ}\text{C} \sim 25^{\circ}\text{C}$

Introduction of different modes:

The heat pump has two modes: Max and Silent. They have different strengths under different conditions.

Mode	Modes	Strength
	Max mode	Heating capacity: 20% to 100% capacity Intelligent optimization Fast heating
	Silent mode	Heating capacity: 20% to 65% capacity Silent Heating

3.2 Swimming pool water parameters

The heat pump is designed for heating the swimming pool water. Although the water heat exchanger is made from the most durable titanium, in order to ensure long term reliability of the heat pump the pool water must be in accordance with the related sanitary requirements.

The limit values for the heat pump operation are the following:

- pH value ranging from 6.8 to 7.9,
- total chlorine amount not exceeding 3 mg/l,
- salt content 6% wt/wt.

Should you have different values of pH, chlorine or salt please try to apply appropriate agents or contact your swimming pool builder to resolve the situation. Above mentioned values are recommended for pools in general.

It is also advised to keep the water hardness on the lower limit of the optimal range, i.e. closely above 8°N .

3.3 Heat pump dimensions

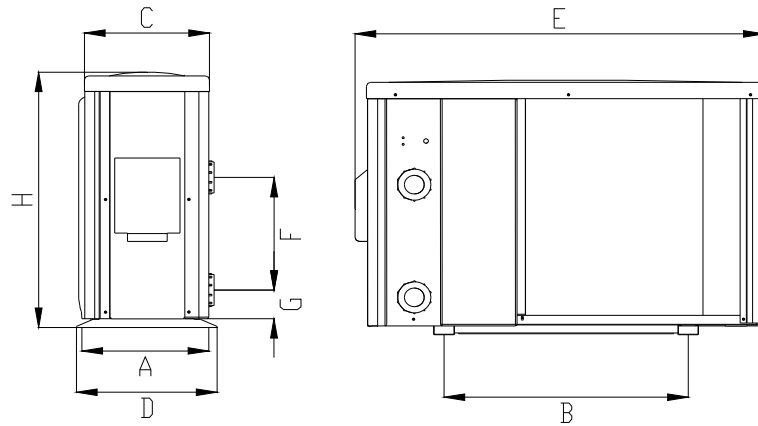

	A	B	C	D	E	F	G	H
HP1100 GREEN INVERTER PRO	315	590	302	340	990	290	74	657
HP1500 GREEN INVERTER PRO	315	590	302	340	990	340	74	657

3.4 Description of the basic parts

Note: The illustrations and descriptions found in this Installation and user manual are not binding. The manufacturer reserves the right to make corrections or changes without notice.

CONDENSING UNIT - COMPACT VERSION

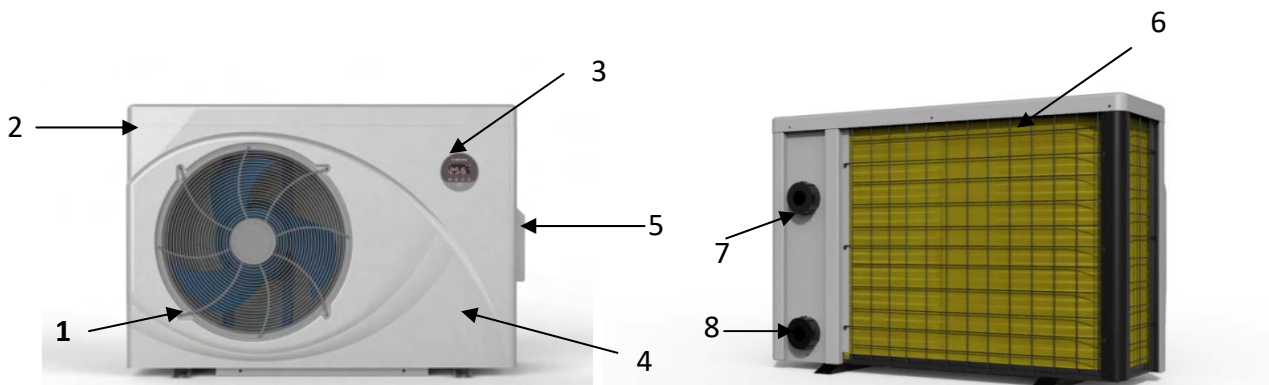

- Legend:**
- 1 – Protecting grates of the fan(air outlet)/ventilator cover
 - 2 – Cover / ABS chassis
 - 3 – Control panel
 - 4 – Valve for refilling the refrigerant (under the cover)
 - 5 – Power supply connection (underneath the plastic cover)
 - 6 – Evaporator (air inlet)
 - 7 – Water outlet connection hub
 - 8 – Water inlet connection hub

3.5 Installation reminder

Only a professional staff is allowed to install the heat pump. The users are not qualified to install by themselves, otherwise the heat pump might be damaged and risky for users' safety.

Location and dimension

 The pool heat pump should be installed in a good ventilation place.

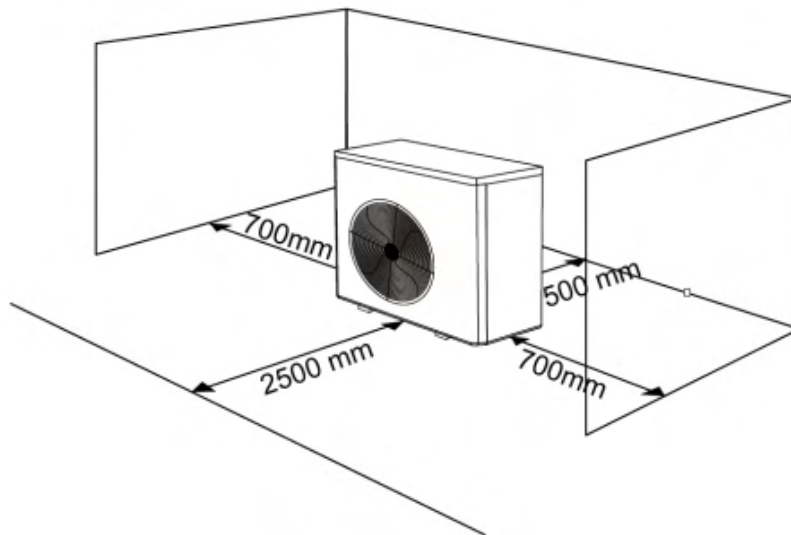

It is advised to install the condensing unit on a **stand 300-500mm above surrounding ground**. Heat pump installed directly on a surrounding ground can be easily immersed into snow and/or into frozen condensation. This can decrease heat pump's efficiency and performance and lead to heat pump malfunction, damage or failure.

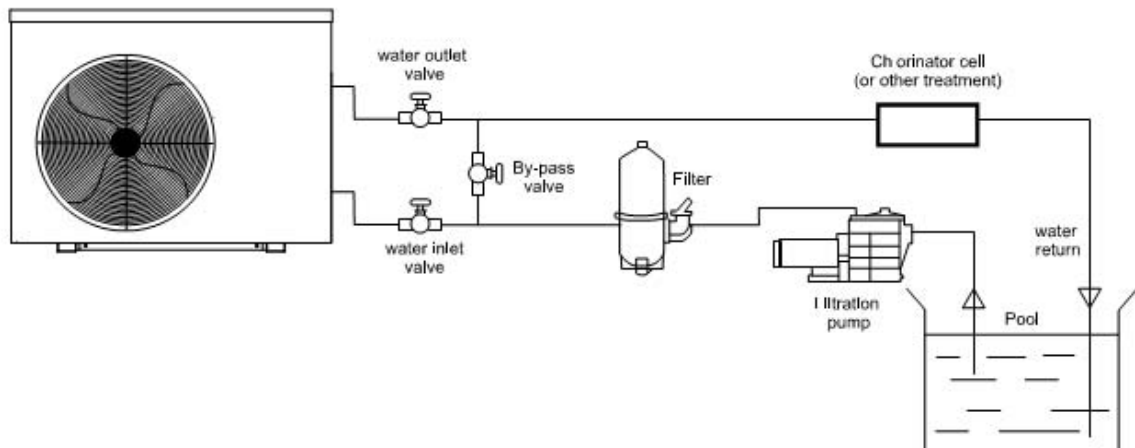

- 1) The frame must be fixed by bolts (M10) to concrete foundation or brackets. The concrete foundation must be solid and fastened; the bracket must be strong enough and antirust treated;
- 2) Please don't stack substances that will block air flow near inlet or outlet area, and there is no barrier within 50cm behind and 250cm in front of the machine, or the efficiency of the heater will be reduced or even stopped;
- 3) The machine needs an appended pump (Supplied by the user). The recommended pump specification-flux: refer to Technical Parameter, Max. lift $\geq 10\text{m}$;

4) When the machine is running, there will be condensation water discharged from the bottom, please pay attention to it. Please hold the drainage nozzle (accessory) into the hole and clip it well, and then connect a pipe to drain the condensation water out.

 The inlet and outlet water unions can't stand the weight of soft pipes. The heat pump must be connected with hard pipes!

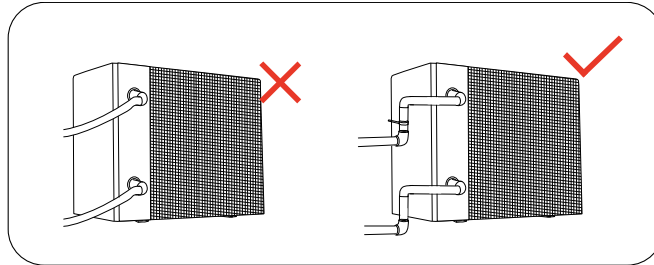

3.6 Accessories

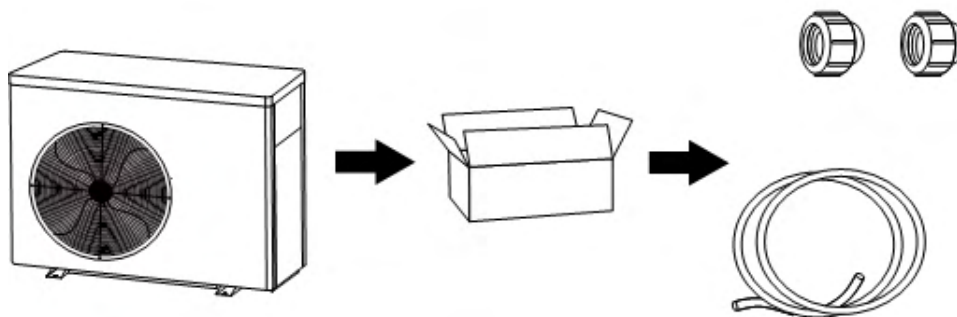

Features

- Stepless DC inverter compressor
- EEV Technology
- Quick hot gas defrosting with Saginomiya 4-way valve
- High-efficiency twisted titanium heat exchanger
- High pressure and low pressure protection
- Soft start & wide voltage application
- Stable inverter control system

3.7 Electric wiring Diagram

- Connect to appropriate power supply, the voltage should comply with the rated voltage of the products.
- Earth the machine well.
- Wiring must be handled by a professional technician according to the circuit diagram.
- Set leakage protector according to the local code for wiring (leakage operating current $\leq 30\text{mA}$).
- The layout of power cable and signal cable should be orderly and not affecting each other.

Electric wiring Diagram - For power supply: 230V 50Hz

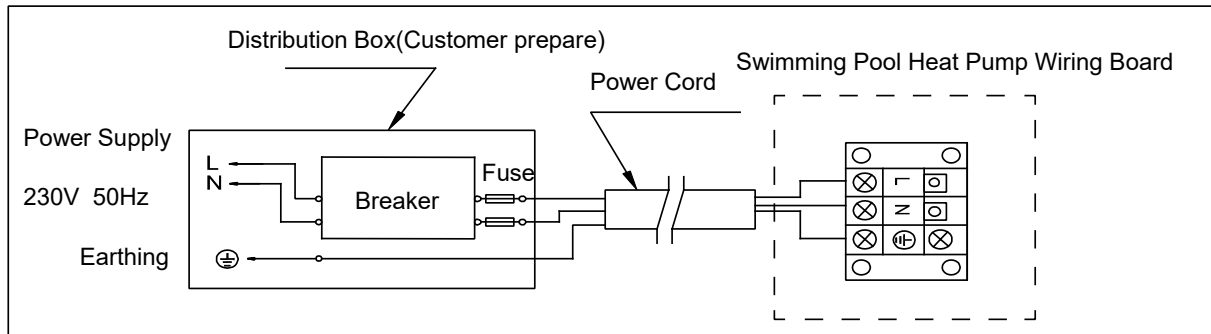

Reference for protecting devices and cable specification

MODEL		HP1100 GREEN INVERTER PRO	HP1500 GREEN INVERTER PRO
Breaker	Rated Current (A)	12.0	17.0
	Rated Residual Action Current mA	30	30
Fuse (A)		12.0	17.0
Power Cord (mm ²)		3×2.5	3×2.5
Signal cable (mm ²)		3×0.5	3×0.5

※ Above data is subject to modification without notice.

Note: The above data is adapted to power cord ≤ 10m. If power cord is > 10m, wire diameter must be increased. The signal cable can be extended to 50m maximumly.

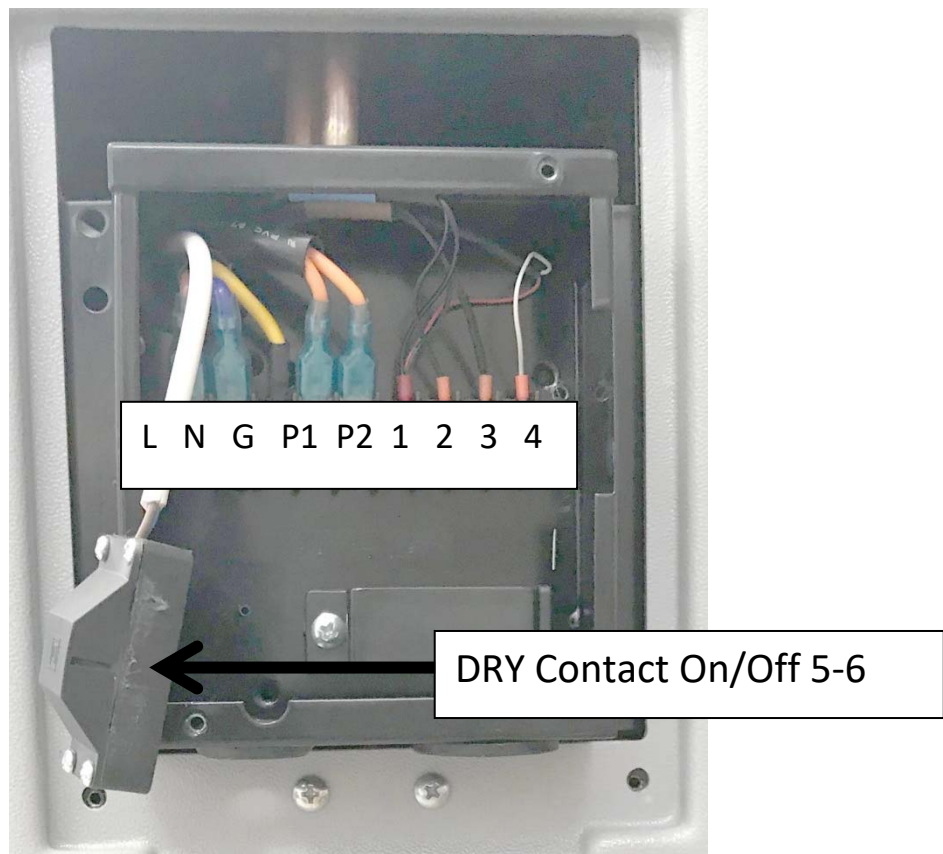

For water pump: Voltage 230V, Capacity $\leq 500W$

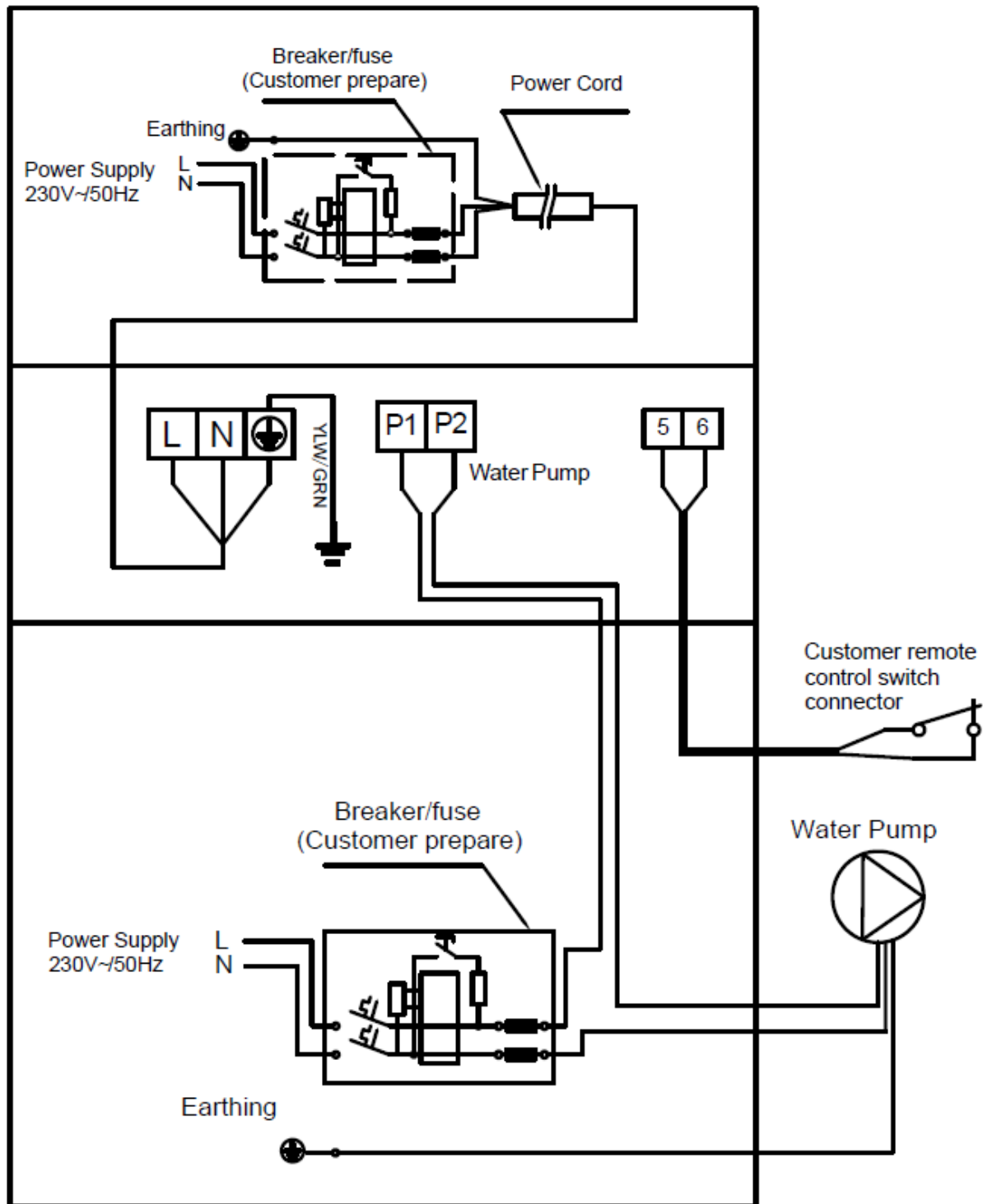

For water pump: Voltage 230V, Capacity > 500W

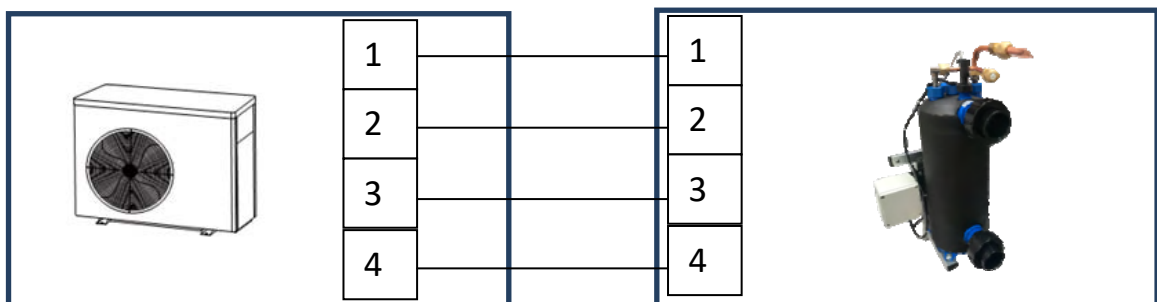
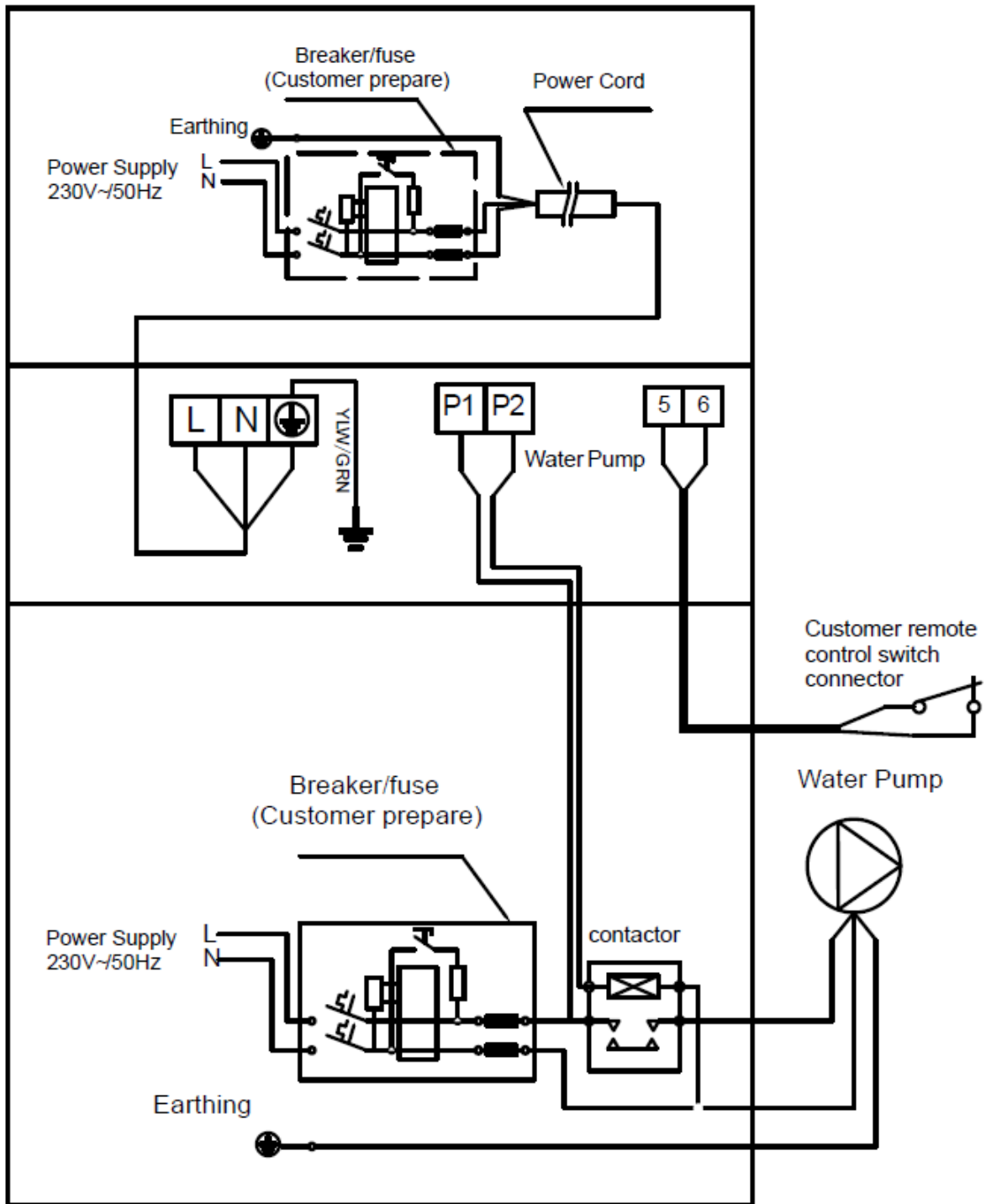

For water pump: Voltage 400V

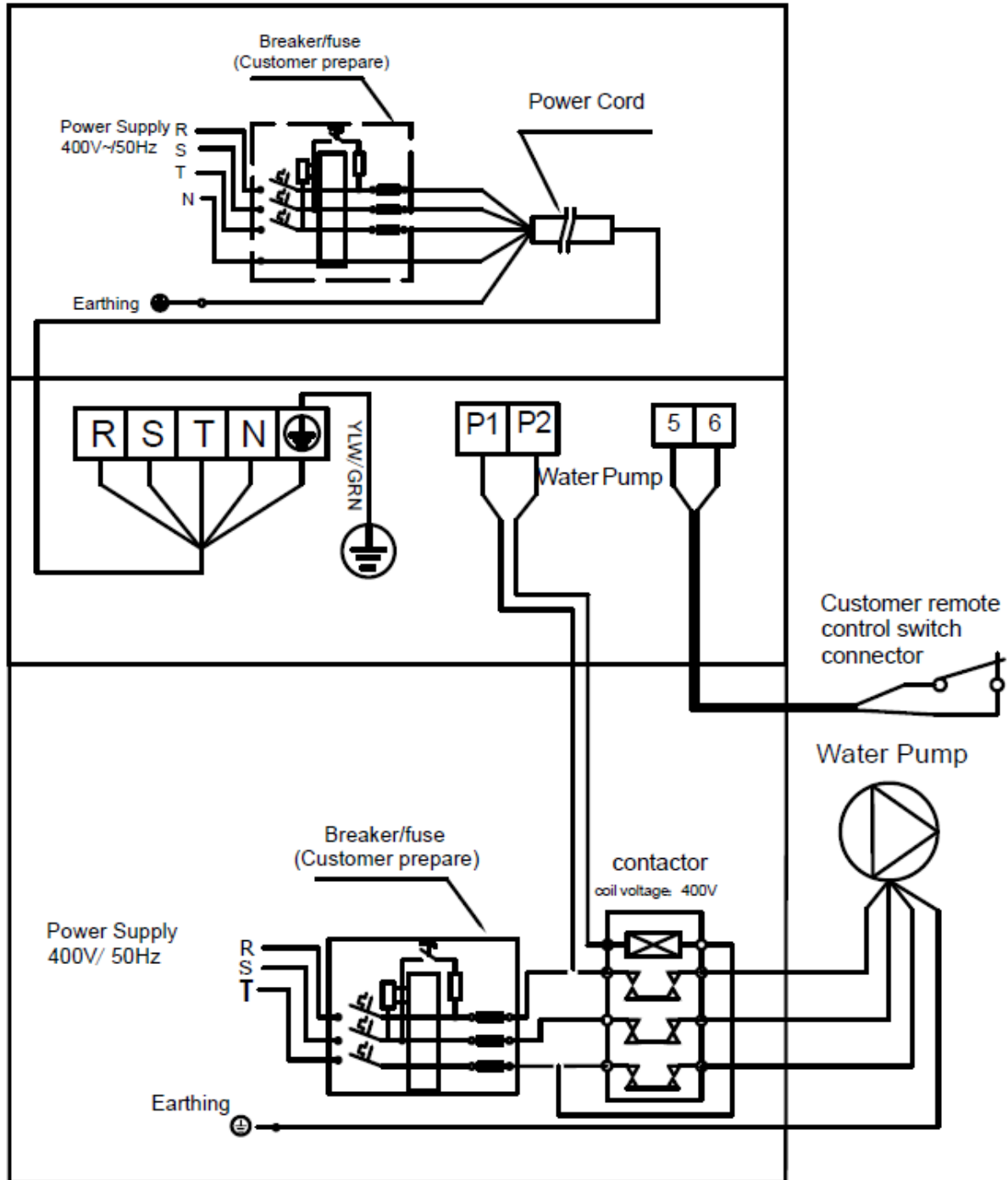

Water pump control and timer connection

1: Water pump timer

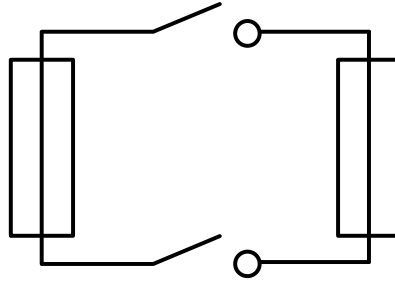







2: Water pump wiring of Heat Pump

Note: The installer should connect 1 parallel with 2 (as above picture). To start the water pump, condition 1 or 2 is connected. To stop the water pump, both 1 and 2 should be disconnected.

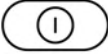

4. REGULATION

4.1 Description of the LCD panel



Symbol	Designation	Function
	ON/OFF	Power On/Off Wifi setting
	Unlock/Heating & Cooling selection	Automatic heating & cooling mode Heating Mode Cooling Mode Lock/Unlock Screen
	Speed Mode	Two modes for switching (Max  , Silence )
	UP/DOWN	Temperature Setting & Displaying

Attention:



- Standby mode or Screen lock : Only  light up, screen and other buttons turn dark.
- Power off : Only  light up, No display on screen.
- The controller has power-saving function.

4.2 Operation Instruction

a. Screen Lock

- 1) Press  for 3 seconds to lock or unlock the screen
- 2) Automatic Lock Period: 30 seconds if no operation

b. Power On

Press  for 3 seconds to unlock screen, Press  to power on machine.

c. Temperature Setting

Press  and  to display and adjust set temperature.

d. Mode Selection

- 1) Press  to switch among heating , Cooling  and automatic mode .

Heating mode: Water setting range(18-40°C)

Cooling mode: Water setting range(12~30°C)

Automatic heating/cooling mode: Water setting range(12~40°C)

When water inlet temperature is higher than setting point, automatic cooling mode starts



When water inlet temperature is lower than setting point, automatic heating mode starts



- 2) Press“  ” to switch among Max mode , Silent mode 



Default mode: Max 

Please choose Max mode  for initial heating



e. WIFI





When the screen is on, press "" for 3 seconds, after "" flashing, enter WIFI connection.

Connect Wifi on mobile phone and input password, then control equipment by Wifi, When APP connects WIFI successfully, "" lights on. When setting by APP, "" flashing.

Clear Wifi setting history: When screen is on, press "" for 10 seconds, after "" flashing for 10 seconds, "" lights off.



f. Defrosting

1) Active defrosting: When machine is defrosting,  is flashing; after defrosting  stop flashing.

2) Forced defrosting: When machine is heating and the compressor is working continuously for 10 minutes, press  and  simultaneously for 5 seconds to start forced defrosting,  is flashing and defrost starts,  stop flashing and defrosting stops.

(Remarks: the interval between forced defrosting should be more than 30 minutes.)

Parameters Checking

1) Press "" and "" together for 5 seconds, after sound "Di", enter "parameter checking" status, parameter code NO. "P0" and default parameter value "2" will display.

2) Press "" Key and "" Key to check the parameters.

3) Press "" key to exit "parameter checking" status.

Parameter Table

NO.	Content	Adjust range	Step length	Default
P0	Water pump running way	0 : Continuation 1 : Water temp control 2 : microECONOMY+	1	0
P1	Time setting (only available when the water pump running way is set to "2"	10 ~ 120 min	5 min	60 min
P2	Compressor continuously running time in defrosting mode	30 ~ 90min	1min	35 min
P3	Defrosting start temp	-17 ~ 0°C	1°C	-7°C
P4	Defrosting running time	1 ~ 12min	1min	12 min
P5	Defrosting quit temp	8 ~ 30°C	1°C	13°C
P10	Compressor speed control	0 : Auto, 1 : Manual	1	0
P12	Electronic expansion valve overheat level (heating)	-10 ~ 20	1	3
P13	Electronic expansion valve overheat level (cooling)	-10 ~ 20	1	5
P14	Electronic expansion valve manual/auto	0 : Auto, 1 : Manual	1	0
P15	Electronic expansion valve opening setting (heating)	50 ~ 240	2P	175 (H5)
P16	Electronic expansion valve opening setting (cooling)	50 ~ 240	2P	175 (H5)
P20	Power off memory function	0 — NO, 1 — YES	1	1

Running status checking

Press "" for 5 seconds, a sound of "Di" can be heard and it will enter into running status checking, at this time, the display alternately shows status point "C0" and its corresponding value.

Change status pointer through "" and "", the corresponding value also changes with it.

Press "" can quit "running status checking" mode

Running status checking table

Symbol	Content	Unit
C0	Inlet water temp	°C
C1	Outlet water temp	°C
C2	Ambient temp	°C
C3	Exhaust temp (compressor)	°C
C4	Outer coil pipe temp (GoldFin evaporator)	°C
C5	Gas return temp (Suction)	°C
C6	Inner coil pipe tem	°C
C9	Radiator temp (Inverter board)	°C
C10	Electronic expansion valve opening	P
C11	DC fan speed	r/min

4.3 Testing

- 1) Inspect heat pump before use
 - a. The ventilating device and outlets are operating adequately and are not obstructed.
 - b. It's prohibited to install refrigeration pipe or components in corrosive environment.
 - c. Inspect the electric wiring on basis of the electric wiring diagram and earthing connection.
 - d. Double confirm the main machine power switch should be off.
 - e. Inspect the temperature setting.
 - f. Inspect the air inlet and outlet.
- 2) Leakage detection notice and method



Leakage checking is prohibited in closed area.

- a. The ignition source is prohibited during the leakage inspection. A halide torch (or any other detector using a naked flame) shall not be used.
- b. Leakage detection fluids can be applied with most refrigerants but the use of detergents containing chlorine shall be avoided as the chlorine may react with the refrigerant and corrode the copper pipe.
- c. Vacuumize completely before welding. Welding can only be carried out by professional

personnel in service center.

- d. Please stop using while gas leakage occur, and contact professional personnel in service center.
- 3) Trial
- a. The user must “Start the Pump before the Machine, and Turn off the Machine before the Pump”, or the machine will be damaged.
 - b. Before start the heat pump, please check for any leakage of water; and set suitable temperature in the thermostat, and then switch on power supply.
 - c. In order to protect the swimming pool heater, the machine is equipped with a time lag starting function, the fan will run 1 minute earlier than the compressor when starting the machine, and it will stop running 1 minute later than the compressor when power off the machine.
 - d. After the swimming pool heater start up, please kindly checking for any abnormal noise from the machine.

5. WIFI OPERATION

① APP Download



Android please download from



iPhone please download from



② Account Registration

1. Register by mobile or email



Note: By downloading and using this application You accept that MICROWELL, spol. s r.o. is a third-party application broker and is not responsible for any technical conditions of its use.

2. Create your password

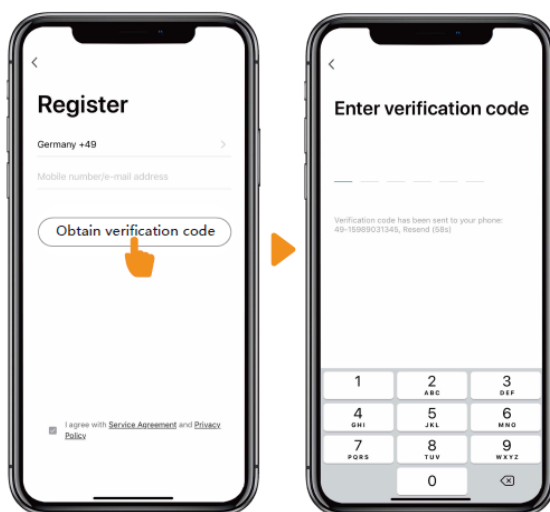

③ APP Binding

Please make sure you are connected to the Wi-Fi.

Press "⏻" for 3 seconds to unlock the screen, press "⏻" for 3 seconds then release, after hearing "Beep".

Enter Wi-Fi code. During connection, "📶" flashes. When the APP connects to the Wi-Fi successfully, the "📶" will come on.



Click "Add device", and then follow instructions to pair device.

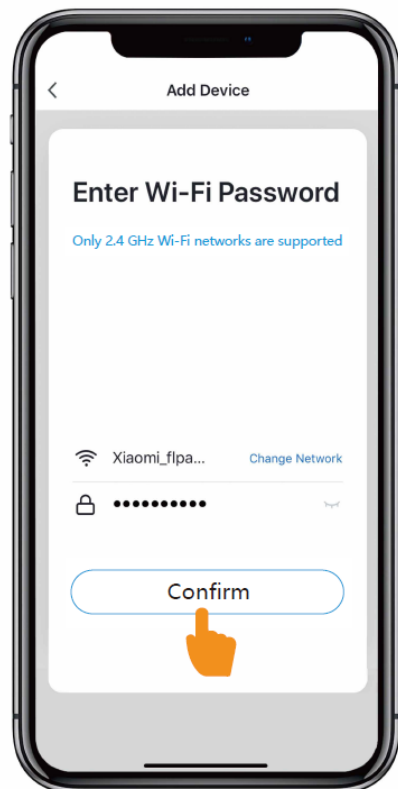
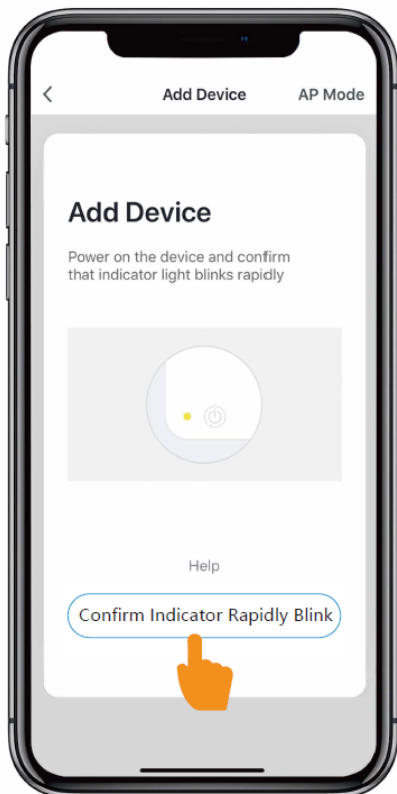
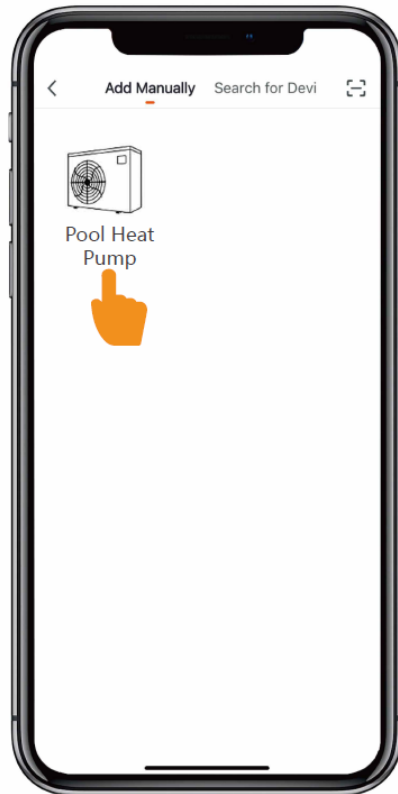
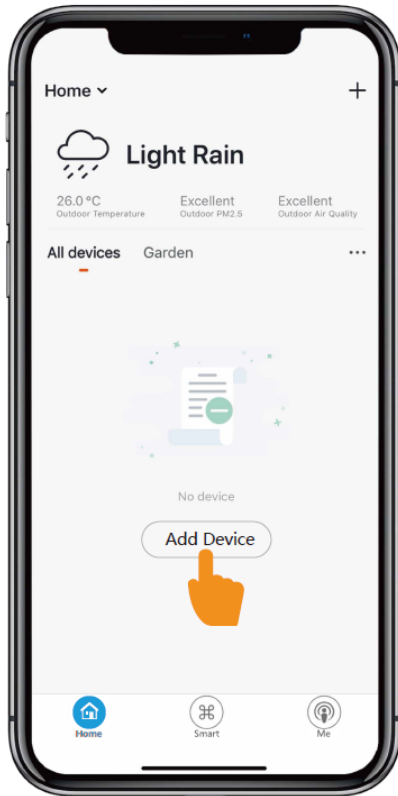

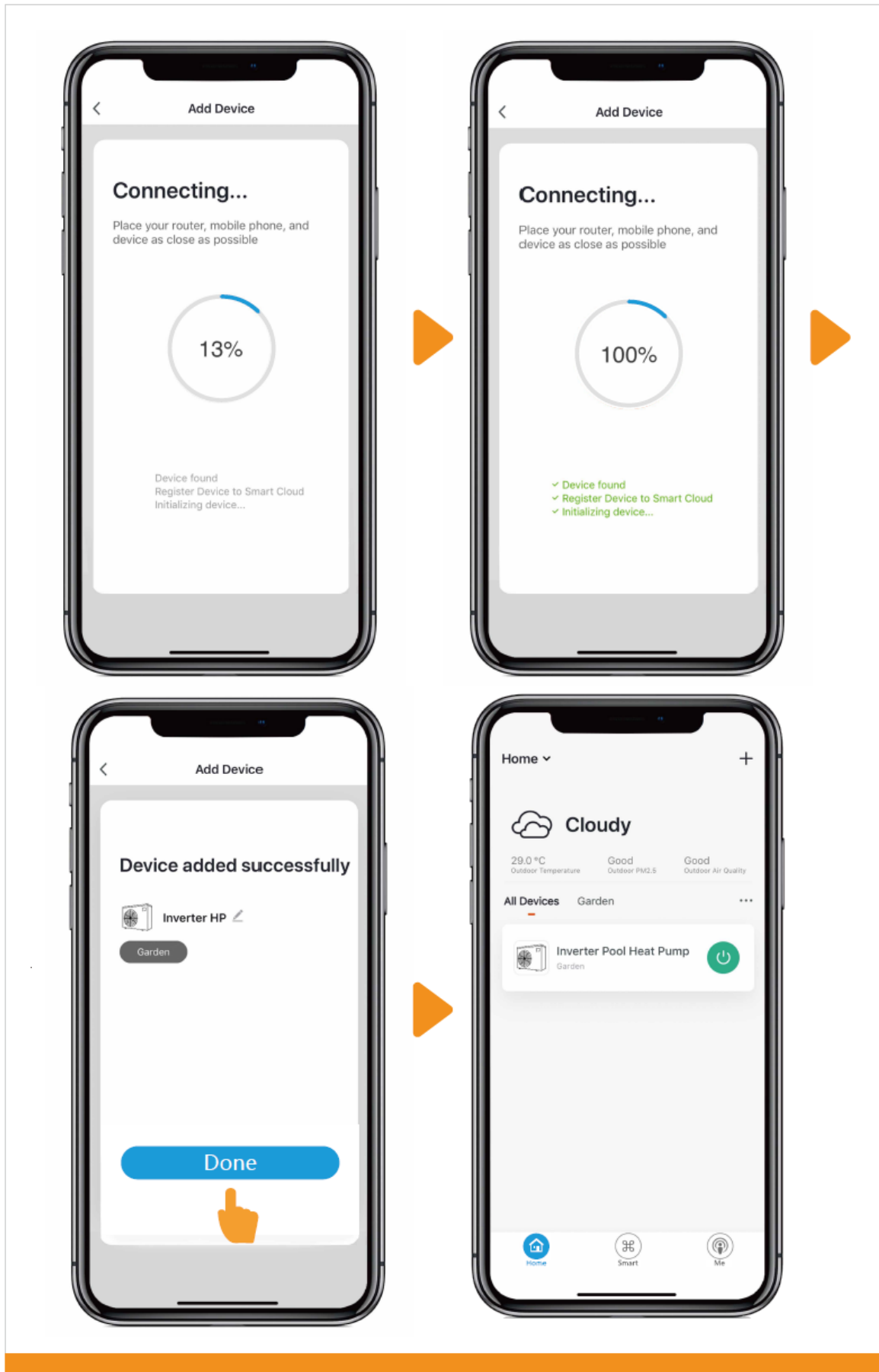

④ Operation

For heat pump with Heating & Cooling function :

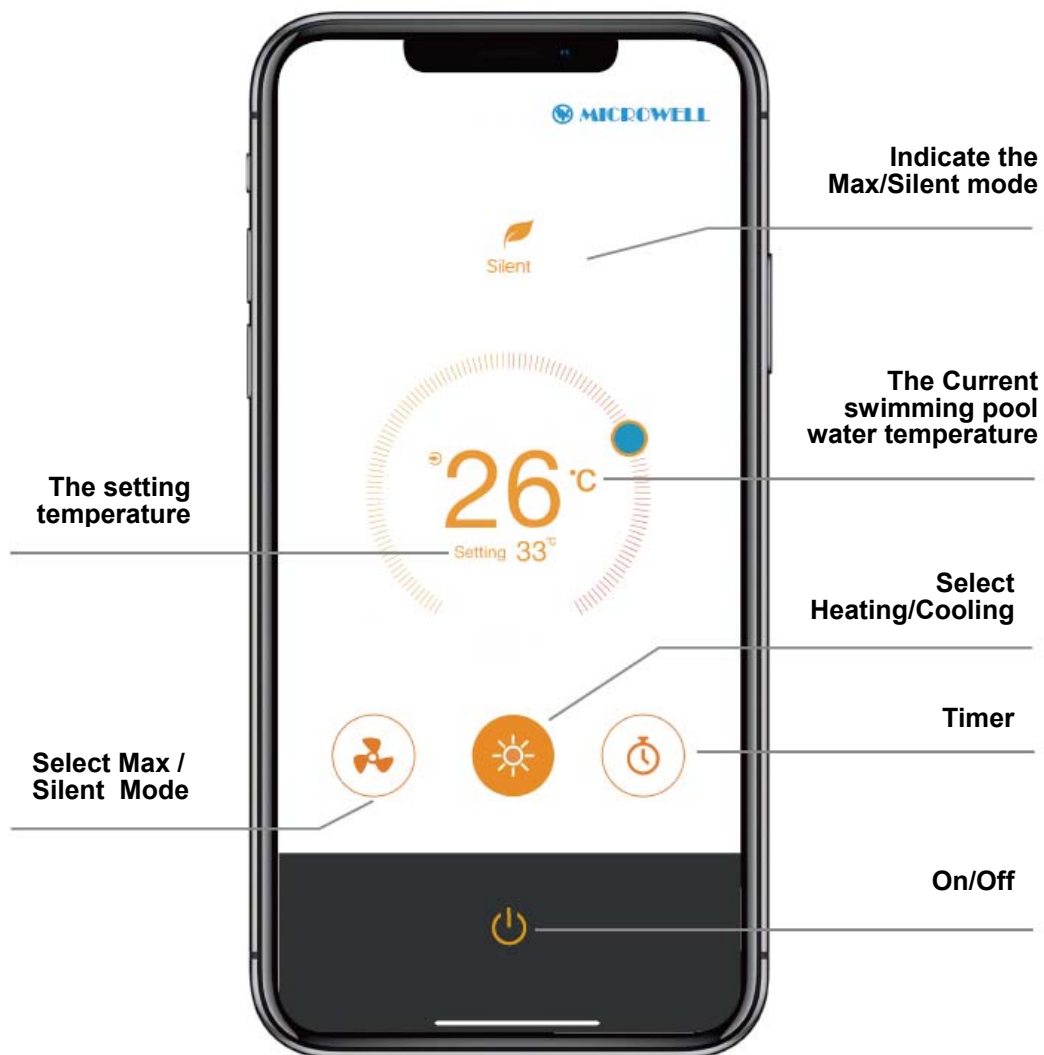

Notice:

- 1.The weather forecast is just for reference.
- 2.APP is subject to updating without notice.

6. TROUBLE SHOOTING FOR COMMON FAULTS

6.1 Repairing Guidance



WARNING:

- a. If repair or scrap is required, pls contact authorized service center nearby.
- b. Requirements for Service Personnel
- c. Any person who is involved with working on or breaking into a refrigerant circuit should hold a current valid certificate from an industry-accredited assessment authority, which authorizes their competence to handle refrigerants safely in accordance with an industry recognized assessment specification.
- d. Do not attempt to work on the equipment by yourself. Improper operation may cause danger.
- e. Strictly comply with the manufacturer's requirements when charging R32 gas and equipment maintenance. This chapter focuses on special maintenance requirements for swimming pool heat pump with R32 gas. Please refer to the technical service manual for detailed maintenance operation.
- f. Vacuumize completely before welding. Welding can only be carried out by professional personnel in service center.

6.2 Failure solution and code

Failure	Reason	Solution
Heat pump doesn't run	No power	Wait until the power recovers
	Power switch is off	Switch on the power
	Fuse burned	Check and change the fuse
	The breaker is off	Check and turn on the breaker
Fan running but with insufficient heating	Evaporator blocked	Remove the obstacles
	Air outlet blocked	Remove the obstacles
	3 minutes start delay	Wait patiently
Display normal, but no heating	Set temp. too low	Set proper heating temp.
	3 minutes start delay	Wait patiently
If above solutions don't work, please contact your installer with detailed information and your model number. Don't try to repair it yourself.		

Note: If the following conditions happen, please stop the machine immediately, and cut off the power supply immediately, then contact your dealer:

1. Inaccurate switch action.
2. The fuse is frequently broken or leakage circuit breaker jumped.

Protection & Failure code

NO.	Display	Not failure description
1	E3	Low or no water flow (filter pump off or water valves closed) or flow sensor error
2	E5	Power supply exceeds operation range
3	E6	Excessive temp difference between inlet and outlet water(Insufficient water flow protection)
4	Eb	Ambient temperature too high or too low protection
5	Ed	Anti-freezing reminder
NO.	Display	Failure description
1	E1	High pressure protection
2	E2	Low pressure protection
3	E4	3 phase sequence protection (three phase only)
4	E7	Water outlet temp too high or too low protection
5	E8	High exhaust temp protection
6	EA	Evaporator overheat protection (only at cooling mode)
7	P0	Controller communication failure
8	P1	Water inlet temp sensor failure
9	P2	Water outlet temp sensor failure
10	P3	Gas exhaust temp sensor failure
11	P4	Evaporator coil pipe temp sensor failure
12	P5	Gas return temp sensor failure
13	P6	Cooling coil pipe temp sensor failure
14	P7	Ambient temp sensor failure
15	P8	Cooling plate sensor failure
16	P9	Current sensor failure
17	PA	Restart memory failure
18	F1	Failure of the compressor drive module / this is an activation of the inverter board protection / it can be a unique activation, as the inverter board is sensitive to fluctuations in the power supply or peaks in the network /. Restart the heat pump by switching the circuit breaker off and on (min. 60 seconds). If the error message is repeated more than few times, contact your dealer.
19	F2	PFC module failure
20	F3	Compressor start failure
21	F4	Compressor running failure
22	F5	Inverter board over current protection
23	F6	Inverter board overheat protection
24	F7	Current protection

25	F8	Cooling plate overheat protection
26	F9	Fan motor failure
27	Fb	Power filter plate No-power protection
28	FA	PFC module over current protection

7. MAINTENANCE



“CUT OFF” power supply of the heater before cleaning, examination and repairing

1. In winter season when you don't swim:
 - a. Cut off power supply to prevent any machine damage.
 - b. Drain water clear of the machine.

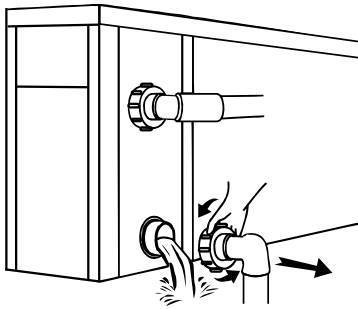

Important:



Unscrew the water nozzle of inlet pipe to let the water flow out.

When the water in machine freezes in winter season, the titanium heat exchanger may be damaged.

This applies to COMPACT version.

- c. Cover the machine body when not in use.
2. Please clean this machine with household detergents or clean water, NEVER use gasoline, thinners or any similar fuel.
 3. Check bolts, cables and connections regularly.
 4. If repair or scrap is required, pls contact authorized service center nearby.
 5. Do not attempt to work on the equipment by yourself. Improper operation may cause danger.
 6. In case of risking, safety inspection must be carried before the maintenance or repairing for heat pumps with R32 gas.



Split version of the heat pump in principle is designed for year round operations. Water unit of the unit heat pump is typically placed in space such as technical or plant room. Split heat pump does not require winterizing, draining of water for the winter if the location of its installation is in constantly above zero temperatures.

8. SPLIT - CONNECTION AND INSTALLATION

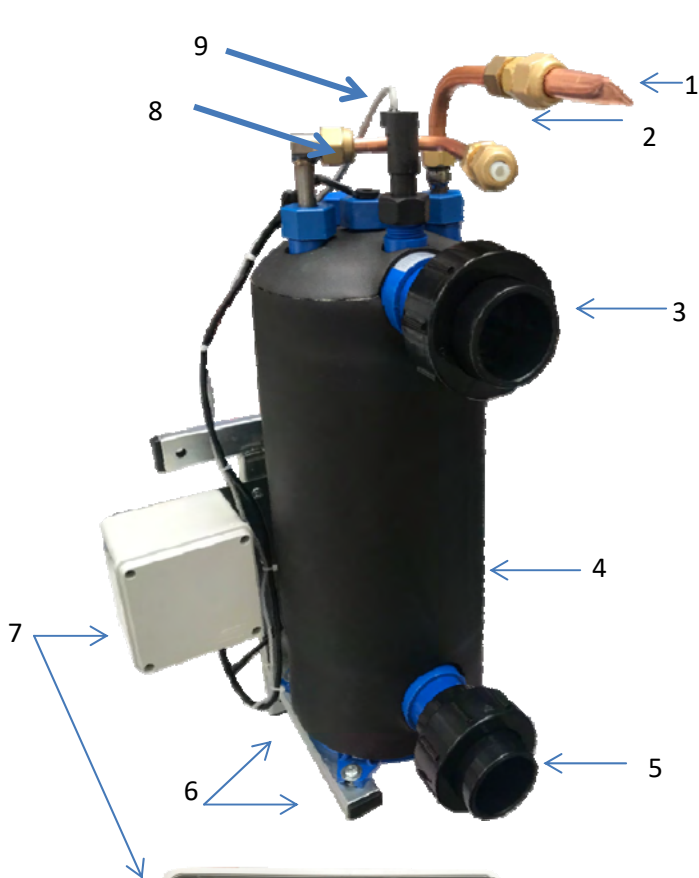

1. Gas R32
2. Gas R32
3. Water OUT
4. Heat exchanger body
5. Water IN
6. Screws fixing the exchanger on console 4x
7. Electro connection compartment
8. Water out sensor
9. Flow switch
10. Water in sensor
11. Fixation holes for screws to fix the console on a wall 4x
12. Main electrical connection of the condensing unit
13. Condensing /compressor / unit
14. Gas R32
15. Gas R32
16. Interconnecting cable /on demand/

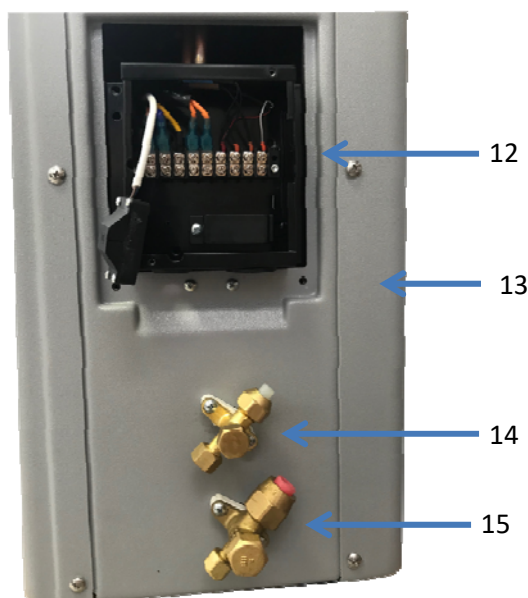
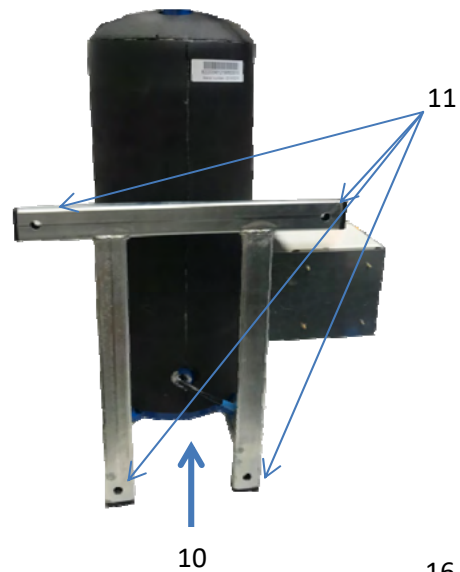

Refrigerant circuit connection

Split heat pump requires refrigerant circuit connection in order to operate normally. This is normally done during installation of the pump as the pump comes with separate (not connected) condensing and water units refrigerant-wise originally from the factory. Refrigerant circuit must be sealed.



IMPORTANT: Please note that refrigerant connection can be performed by an authorized person only. The person must have a valid refrigeration licence.

Condensing unit is pre-charged with refrigerant R32 from the factory. HP1100 750g and HP1500 900g R32. This is sufficient for 5 meter long copper pipe connection. Above 5 meters 25g/1m must be added to the system.

Piping length and elevation

Heat pump model	Pipe size				Factory pre-charged connection distance	Max. vertical distance (B)	Max. distance (A)	Additional refrigerant for 1m above 5m
	Gas (diameter)		Liquid (diameter)					
	inch	mm	inch	mm				
HP1100	1/2	12	1/4	6.35	5m	15m	25m	25g/m
HP1500	5/8	15.88	3/8	9.52	5m	15m	25m	25g/m

Water unit

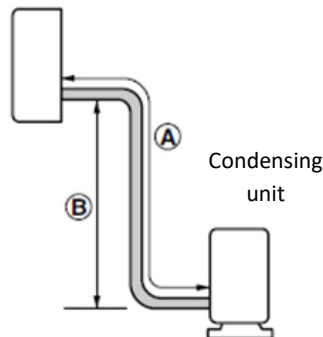

Condensing unit

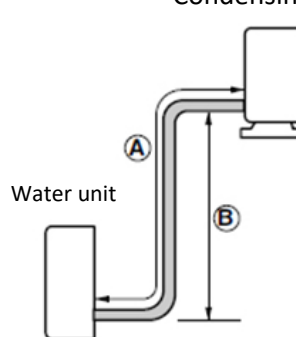

Refrigerant piping – condensing unit

1. Align the center of the pipings and sufficiently tighten the flare nut by hand. Please do so for both gas and liquid pipes.

Gas pipe has bigger diameter.

Liquid pipe has smaller diameter.

2. Tighten the flare nuts with torque wrench until the wrench clicks. Please make sure that the direction for tightening follows the arrow on the wrench.

Please review below table for torque force.

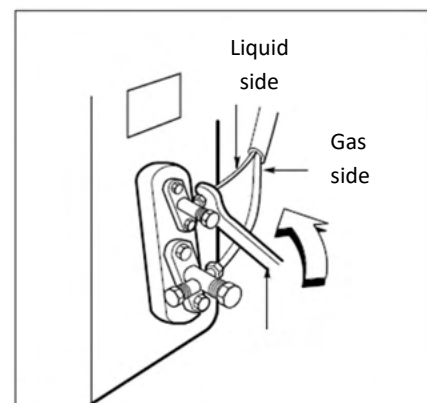
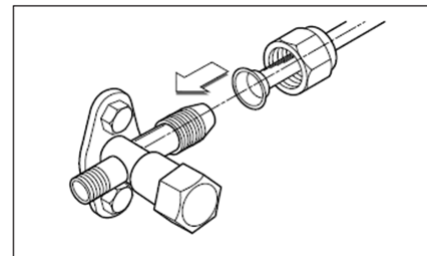

Please use refrigerant copper pipes with insulation only.



Torque
wrench

Outside diameter		Torque kgf m
inch	mm	
¼	6.35	1.8-2.5
3/8	9.52	3.4-4.2
½	12.7	5.5-6.6
5/8	15.88	6.3-8.2

3. Forming and insulation the piping.

The pipes must be insulation and secured with vinyl tapes. This is done in order to prevent condensation on the piping.

It is highly advised to place the piping into a plastic protector when installed in the ground (soil).

On places where piping goes through a wall or similar it is advised to use gum type sealer or construction foam to seal the openings.

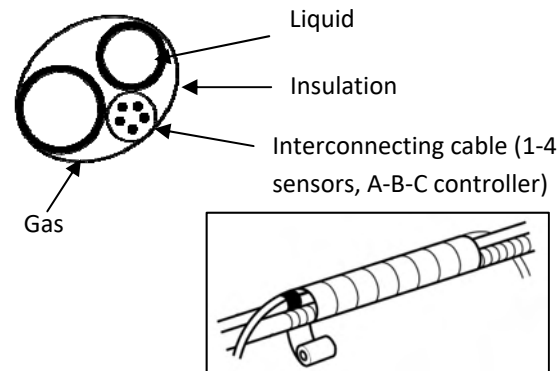

3.1. Condensing unit below water unit

Tape the piping and interconnecting cable from down upwards. Fix the tapped piping with cable binder or equivalent onto the exterior wall. It is important to make a trap to prevent water from entering into the electro installation of the condensing unit.

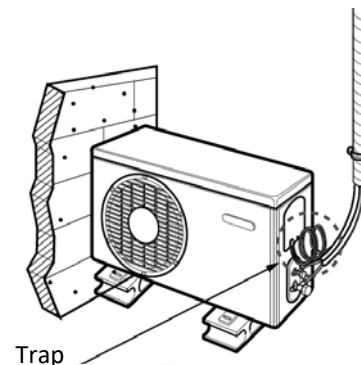

3.2 Condensing unit above water unit

Tape the piping and interconnecting cable from down upwards. Fix the tapped piping with cable binder or equivalent onto the exterior wall. It is important to make a trap to prevent water from entering into the electro installation of the condensing unit. On refrigerant side it is important to form a syphon.

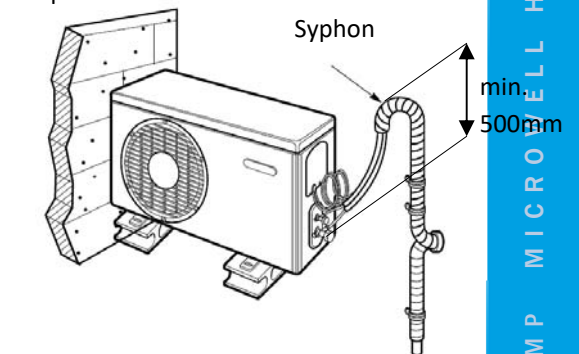

Flaring work

It is important to perform the flaring work correctly. This will have positive effect towards long-term reliability and functionality of the heat pump. Defective or incorrect flaring work is the most common cause for gas leakage. Gas leakage results in continuous decrease of heat pump efficiency and eventually leads into security turning off, malfunction, failure or damage.



Warranty does not cover any product, property or personal damages or losses that are a result of incorrect flaring work, gas leakage, incorrect welding work or improper material used.



When cutting the pipes and cables, please mind the following:

1. Measure the distance between the water and the condensing unit.
2. Cut the pipes a little longer than measured distance.
3. Cut the cable 1.5m longer than the pipe length.

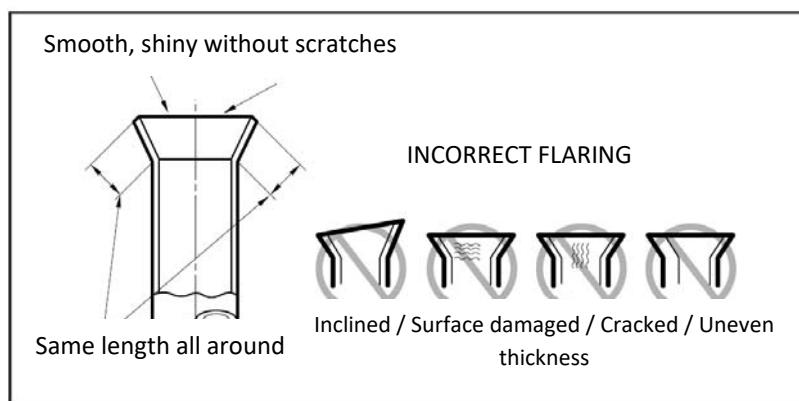
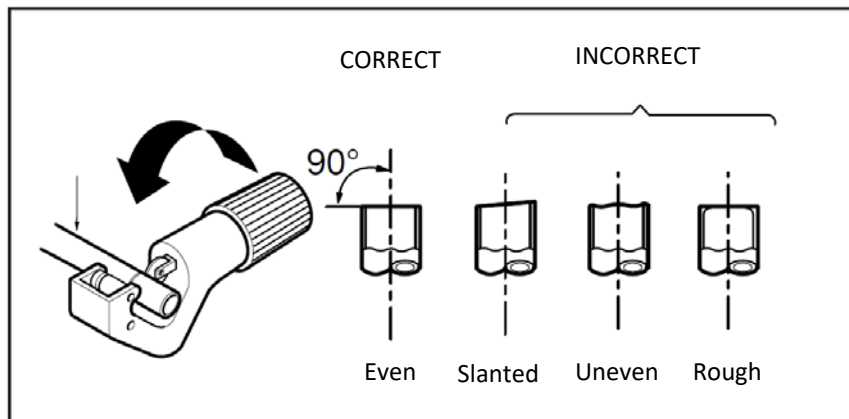

Pressure test / Air purging

Sometimes bits of air and moisture remains in the refrigerant circuit. If this is not treated, following symptoms may appear on your heat pump:

1. Pressure in the system rises.
2. Operating current rises.
3. Heating or cooling efficiency drops.
4. Blockage of capillary tube due to frozen moisture resulting in complete failure of the heat pump.
5. Corrosion of refrigerant circuit.

It is thus highly advised to take a leak test after evacuating the complete system. Leak test can be performed with usual methods using manifold valve and/or soap water. Air purging can be performed by most commonly applied methods with vacuum pump. This Installation and user manual elaborates vacuum pump method.



When the condensing unit is pre-charged with refrigerant we do not recommend a pressure test using nitrogen.



Air purging with vacuum pump

1. Preparation
 - a. Check that each tube (both liquid and gas) between the water and condensing units have been properly connected and all wiring for the test run has been completed.
 - b. Remove the service valve caps from both the gas and the liquid side on the condensing unit. Please note that both the liquid and the gas side service valves on the condensing unit are kept closed at this stage. Some heat pumps models have in their refrigerant circuit only 1 service valve installed.
2. Lead test by vacuuming
 - a. Connect the charge hose end described in the preceding steps to the vacuum pump to evacuate the tubing and water unit. Confirm the "Lo" knob of the manifold valve is open. Then, run the vacuum pump. The operation time for evacuation varies with tubing length and capacity of the pump. The following table shows the time required for evacuation when using a vacuum pump of 30 gal/h power.

Required time for evacuation when 30 gal/h vacuum pump model is used	
Tube length less than 10m	Tube length more than 10m
Minimum 10 minutes	Minimum 15 minutes

- b. When the desired vacuum is reached, close the "Lo" knob of the manifold valve and stop the vacuum pump.

Finishing the job

1. With a service valve wrench (inbus wrench), turn the valve stem of liquid side valve counter-clockwise to fully open the valve.
2. Turn the valve stem of gas side valve counter-clockwise to fully open the valve.
3. Remove the charging hoses.
4. Put service valve caps back at both gas and liquid side service valves and fasten them tight. This completes air purging with a vacuum pump and refrigerant works.



Please note that above flaring and refrigerant work must be performed correctly with utmost care. Any non-compliance with above may and will likely lead into heat pump's malfunction, failure or damage. Such state means complete warranty void and manufacturer; distributor or reseller cannot be taken responsible in such case for any property or personal damage or loss.

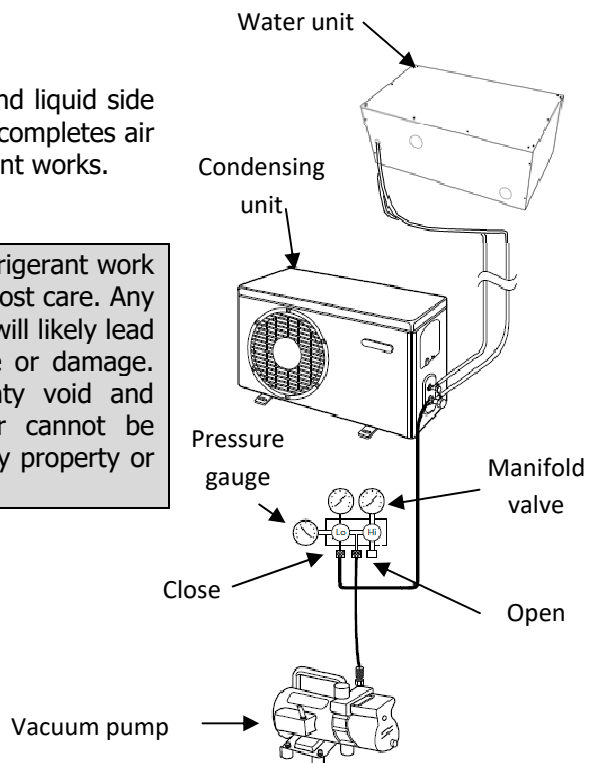

Water unit dimensions

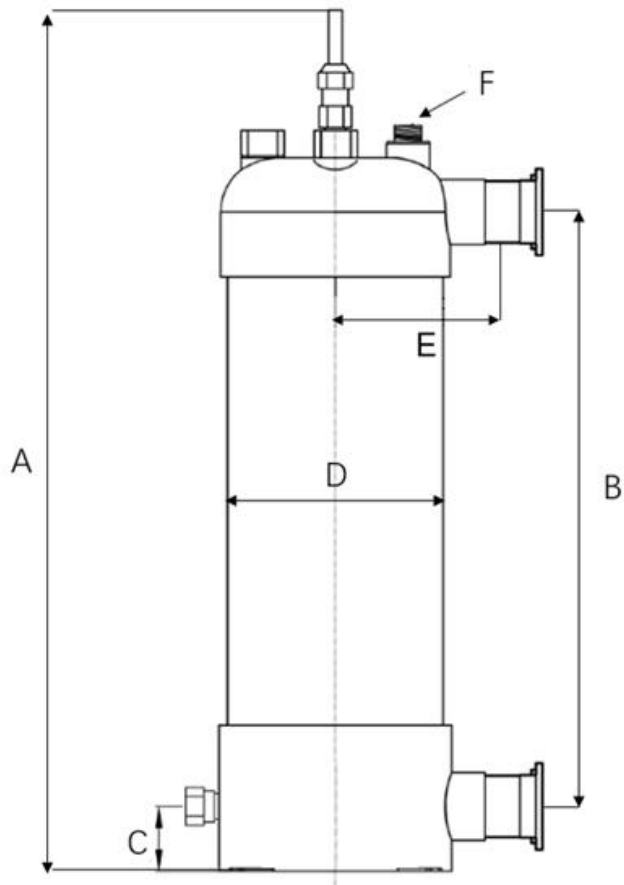

	A	B	C	D	E	F
HP1100	480	290	55	φ160	135	φ32*3/4"
HP1500	520	340	55	φ160	153.5	φ32*3/4"
HP2100	650	460	55	φ160	135	φ32*3/4"
HP2700	830	640	55	φ160	135.5	φ32*3/4"

9. Warranty

Your heat pump is covered by warranty. For particular conditions of this warranty in terms of warranty period and subject please refer to your local regulations and/or agreement with your distributor, reseller or installer. Any action resulting in damage of the heat pump, property or other damage caused by improper usage of this product or in contrary with this Installation and user manual is excluded from warranty coverage.

Distributed by:

Manufacturer:



MICROWELL, spol. s r.o.

SNP 2018/42, 927 01 Sala,



Slovakia

tel.: +421/31/702 0540



fax: +421/31/702 0542

e-mail: microwell@microwell.sk

www.microwell.eu

